

# **Working Group COFREND « Eddy Current NDT modeling »: Benchmarks for validating and improving simulation codes acceptance**

Fabrice FOUCHER<sup>1</sup>, Léa MAURICE<sup>2</sup>, Thierry SOLLIER<sup>3</sup>, Christophe REBOUD<sup>4</sup>, François DENEUVILLE<sup>5</sup>, Adrien TRILLON<sup>5</sup>, Pierre THOMAS<sup>6</sup>

<sup>1</sup> *EXTENDE, 15 Avenue Emile BAUDOT, 91300 Massy, France*

<sup>2</sup> *EDF/CEIDRE, 2 rue Ampère, 93206 Saint Denis, FRANCE*

<sup>3</sup> *Institut de Radioprotection et de Sûreté Nucléaire, 92262 Fontenay, FRANCE*

<sup>4</sup> *CEA LIST, Saclay, 91191 Gif sur Yvette, FRANCE*

<sup>5</sup> *VALLOUREC, Centre de recherche, 60 Route de Leval - BP20149, 59620 Aulnoye-Aymeries, FRANCE*

<sup>6</sup> *EDF R&D, 1, avenue du Général de Gaulle, 92141 Clamart, FRANCE*

## **Abstract**

The working group « Eddy Current NDT modeling », hosted by the French NDT society “COFREND”, aims at proposing benchmark cases with associated experimental results, in order to support the validation and the acceptance of simulation programs, to put closer modeling tools and industrial needs, and finally to allow the NDT community to regularly exchange on the subjects related to Eddy Current simulation. Various types of members have joined the group and regularly participate to the task force: industrial users of NDT, services & engineering companies, universities and research centers. Several sectors are represented (power industry, aerospace, steel industry, etc.). This paper presents the latest works of the group performed within the last year. More precisely, two benchmarks have been addressed, inspired by inspection issues from the nuclear sector and the steel industry. Furthermore, new benchmarks are being proposed in order to be solved by candidate programs.

**Keywords:** Simulation, Eddy Current Testing, Benchmark, French Society of NDT “COFREND”

## **1. Numerical modeling of NDE process**

### ***1.1 Simulation of Eddy Current Testing***

Nowadays, Non Destructive Tests (NDT) are widely used in many industries in order to control the integrity of materials. Modeling tools can bring a significant help at different stages of NDT operations:

- Design of the test process and the inspection procedure
- Performance demonstration
- Help for understanding and expertise of real inspection results
- Training

It can also support Probability of Detection (PoD) campaigns based on uncertainties propagation [1], by reducing the number of physical tests on mock-ups, or by helping defects identification and sizing with inversion methods applied on measured signals. [2]

Numerous papers highlight recent works where simulation played a major role for different industries: aerospace [3], steel industry [4], nuclear power generation, in France [5] or worldwide [6]. For instance, the European Network for Inspection and Qualification (ENIQ) promotes the use simulations (with recommended practice) in the framework of the qualification of a NDT process. [9]

For Eddy Current Testing simulation, various tools exist based on different models (i.e. different ways to adapt and solve Maxwell equations for Eddy Current configurations). A typical Eddy Current test is an AC problem where Maxwell Equations can be reduced to a single harmonic diffusion equation, provided that quasi-static hypothesis can be applied (which is the case in NDT). But, if pulsed Eddy Current is considered, the same hypotheses cannot be applied and a transient model is required.

### ***1.2 Numerical methods***

To solve these equations, a first approach consists in directly discretizing the study domain and solves locally the Maxwell equations with a very restricted introduction of analytical formulae or physical hypotheses such as the Finite Element method (FEM). It is largely used for a wide range of physical problems for which it is quite well suited (mathematically efficient as the equation system can be solved relying on a constant energy level).

Several software or codes dedicated to the solving of electromagnetic problems using Finite Elements can be quoted such as:

- Code\_Carmel3D (current version 2.4), co-developed by EDF R&D and L2EP (Laboratoire d'Electrotechnique et d'Electronique de Puissance de Lille) in a mutual laboratory called LAMEL.
- Flux3D (current version 11.2), software developed and distributed by CEDRAT company,
- Opera (current version 16), software belonging to the software suite Vector Fields Software, edited by Cobham company.
- ANSYS-Maxwell (current version 15.0), software developed and distributed by ANSYS company.
- Comsol-Multiphysics (current version 4.3), multiphysics software including a low frequency electromagnetic module, developed and distributed by the eponymous company.

Finite Volume method is another approach based on the geometrical discretization of the study domain. IREENA (Institut de Recherche en Energie Electrique de Nantes-Atlantique), belonging to Nantes university, develops this type of models [7].

CIVA platform, fully dedicated to the simulation of NDT, developed by CEA DISC and distributed by EXTENDE, also proposes a numerical model based on the Finite Integration Technique to solve some configurations, as a part of its Eddy Current module.

### ***1.3 Semi-analytical Methods***

Another approach is to rely more on analytical formulae. Semi-analytical methods allow, by doing some hypotheses on the geometrical or physical properties of the test configuration, and by using adapted and/or original mathematical tools, to obtain precise results with very interesting calculation times. Moreover, these tools are generally easier to use even if the starting hypotheses generally lead to a more limited validity domain compared to fully numerical models.

Most of the models implemented in the Eddy Current module of the CIVA platform rely on such semi-analytical approach where only the flaw is discretized and implies numerical operations (Volume Integral Method or Boundary Element Method solved using Green dyads operators applied to the test configuration).

### ***1.4 Metamodels for intensive simulation***

Several applications, such as inversion procedures or POD studies, require a very large amount of single results from different individual NDT configurations, to produce the final result. In such situations, it is sometimes necessary to drastically reduce computation times. To meet this requirement, a possible strategy consists in replacing the direct modelling by an approximation based on the knowledge and the extrapolation of the model (only precise in a given variation domain of input data). This « model of the model » called metamodel (also called surface response) can be evaluated very quickly [1,1b].

### ***1.5 Validation of simulation Tools***

Each method has advantages and disadvantages, and to develop a model needs a lot of skills different from the ones required in NDT. As a consequence, prior to use simulation tools, it is necessary to know the validity domain of the code or to perform additional validation tests to ensure its applicability for a given NDT application. The most convincing validation process is to compare simulation results with experimental measurements. Another interesting way is to compare several models together. It is even more interesting when these models are not based on the same method as it allows to evaluate the hypotheses associated to each one (for instance the accounting of boundary conditions at the infinite which distinguish finite element models and semi-analytical/integral approach).

These two types of validation are recommended by the ENIQ. [9]

## **2. Working Group COFREND « Eddy Current Testing Modeling »**

### ***2.1 Description & Goals***

Test cases or "benchmarks" on electromagnetic problems appeared in the 80s'. These benchmarks were generally initiated by code developers, often coming from the academic world. The « Testing Electromagnetic Analysis Method » (TEAM) workshops, developed in the frame of COMPUMAG, have been extended to realist cases including NDT from 1987 [10]. The famous problems 8 and 15 from TEAM Workshops still remain today reference cases for any electromagnetic codes wishing to tackle NDT problems. Other benchmarks more specific to NDT arose in the 90s, such as the ACES Workshops, those proposed by the World Federation of NDE Center in the US, or the JSAEM benchmarks in Japan [11].

But the definition of these benchmarks remained the initiative of academic world and the tested configurations were not fully relevant with respect to nuclear or aerospace typical Eddy Current inspection configurations. As a consequence, it has become necessary for industrials to define test cases closer to their needs as soon as they started to really use such simulation tools. Indeed, the use of a validated code on pure academic benchmarks is often not enough to prevent this code from facing specific problems that can occur on realist industrial cases [12].

The working group « Simulation of Eddy Current NDT», hosted by the French society of NDT "COFREND" ([www.cofrend.com](http://www.cofrend.com)), was born from the statement of a lack of representative validation cases from the industrial world.

Members of this group belong to various fields of activity:

- Industrial end users: VALLOUREC, EDF, AREVA, SNECMA, DASSAULT AVIATION, AIRBUS GROUP,
- Government funded Institute : IRSN

- Academics and Research centers : CEA, Supélec/CNRS (L2S, LGEP), IREENA
- Engineering & consulting companies : EXTENDE
- NDT equipment suppliers : ALPHATEST SYSTEMES

The group was born in 2004, and has regularly organized some meetings from 2005 (about 2 meetings a year with 8 to 15 participants).

The goals that the members have defined are the following:

- **To propose test cases with a unified way of describing them** (see next part),
- **To Promote and give access to the benchmark results:** The working group wishes the COFREND website to hold as soon as possible these test cases,
- **To ease the solving of test cases and the exchange of know-how,**
- **To inform the NDT community about the possibilities of modeling Eddy Current problems:** to highlight the capabilities of the simulation should help to increase the understanding and the acceptance of modeling in industrial NDT processes.

## *2.2 Definition & description of industrial test cases*

As said above, the benchmarks should be close to real industrial configurations. However, all input parameters and output data should be clear and available for everybody, to allow the solving of this benchmark by different people in similar conditions. Therefore, it cannot be subject to confidentiality issues.

The characteristics of a good benchmark are given below:

- **Realist:** The benchmark should be representative of a generic industrial configuration,
- **Simple:** It can be easily described and modeled by a large number of codes,
- **Original:** It does not « repeat » an existing benchmark,
- **Verifiable:** All necessary input data are known and can be published: geometry & material of the work piece, sensor parameters, acquisition data (scanning, frequency, and acquisition channels). It has reference results given from experimental measurements or from other simulated data, acknowledged as a reference solution, which is the basis for a comparison of the results given by the candidate codes.

This exhaustive description of a benchmark is the first task to do...and this is often the more difficult part! Sometimes, it faces problems of confidentiality for ET sensor parameters. Sometimes, it is difficult to know the exact parameters of the part material (especially for ferromagnetic part) and sometimes, the difficulty is also to realize experimental trials or to get experimental data from industrial acquisitions that can be disclosed publicly.

A generic model for the description of a test case has been defined by the group in 2010.

## *2.3 Benchmarks of the COFREND Working group*

This part describes the benchmarks proposed by the WG. Some of them have been solved already by one or several simulation codes while other ones are only at the description stage. This list is not closed and should evolve in the future.

**Benchmark #2:** Through wall/ Internal/ External notches in thin non magnetic & conductive slabs (proposed by EdF-CEA). The industrial origin of this case is the inspection of steam generator tubes in Inconel by rotating probes in nuclear power plants (even if this case has been described in a planar configuration). In particular, it was motivated by the difficulty to solve configurations with through wall flaws [12]. Two types of sensors are proposed: A common function one with a single probe, a separated function one (or “reflection mode”) with 2 coils, operating absolute measurement

**Benchmark #6:** Encircling coils on a stainless steel tube with Flat Bottom Holes (FBH) (proposed by Vallourec). This benchmark addresses the topic of industrial tube inspection at the manufacturing stage on production lines, representative of steel industry issues.

**Benchmark #7:** Very small flaws on plates (by SNECMA & CEA). This benchmark is currently at the description stage and will address the problem of very small flaw (size less than 1mm x 1mm x 1mm) inspected with ferrite-core sensors.

**Benchmark #8:** Remote Field Testing (proposed by CEA). This case has been published by CEA at ENDE 2007 [23]. It involves a notch, FBHs and external grooves in a ferromagnetic tubes (conductivity of 6.25 MS/m and a relative permeability evaluated at 210), inspected with the Remote Field Eddy Current technique (RFT).

**Benchmark #9:** Multi-layer fastened plate (proposed par CEA). This test case comes from aeronautics configurations by considering a bilayer structure separated by a thin air gap and fastened with a rivet. It includes a notch of 0.234mm initiated from the rivet hole, representative of typical cracking phenomena nearby bore areas. The sensor used is a simple coil operating at common function, at 1 & 5 kHz. First results on these cases have already been obtained with CIVA 11.0 and presented at the conference QNDE 2013 [24].

**Benchmark #10:** Multilayers slabs with varying electromagnetic properties (proposed by IRSN, EDF & VALLOUREC). This case is currently in the description stage.

### 3. Software Performance for Eddy Current Simulation

Computation codes capabilities can be expressed through different criteria:

- Versatility: Extent of configuration types that can be simulated,
- Accuracy of results,
- Computation times,
- Graphical User Interface proposed: Easy or not easy to use and requiring few or strong numerical expertise to obtain a good result.

The constant improvement of processors performance allows decreasing computation times while the size of discretization and the versatility of the possibilities increase.

#### 3.1 Finite Element computation improvements

For FEM tools, the volume of discretization for a given NDT configuration, in terms of number of nodes for instance, illustrates the capacity to represent more accurately and with more details the real configurations (e.g. complex geometries) while solving them with a good accuracy. Therefore, this is interesting to notice the evolution of this parameter.

In order to illustrate this, a brief comparison study is performed between 1996 to nowadays, on the basis of the solving of the Team Workshop 8 benchmark. In 1996 [10], Turner mentioned that one of the challenge for the solving of numerical electromagnetic problems was to solve realistic models on a PC. In these days, the TEAM Problem #8 has been solved with the software OPERA on a Pentium PC with a very coarse mesh of 8607 nodes. Computation times were 10 minutes per position, leading to 5 hours for the whole scan. In 2004, the same problem has been solved with Flux on a Pentium 4 @2,4 GHz with a mesh of

145 000 nodes, large enough to reach more precise result on this benchmark. This was a relatively important mesh at this time. But this is now extremely reasonable due to the increasing computation capacities since then, which allows now to simulate NDT configurations much more realistic than the problem #8. The observed computation time in 2004 was 3h30 for 23 positions on a Pentium 4 @2.4 GHz, which was 30% less than in 1996 for a discretization 16 times bigger. In 2014, this problem (with approximately the same number of nodes than in 2004) has been solved with Flux version 11.1 in 35 minutes for the whole scan (on a machine built in 2011). Computations are 4 to 6 times faster than in 2004.

Another remarkable change in computing capabilities is the development of High Performance Computing (HPC) such as «supercomputer» or clusters associated to the capability of distributing or parallelizing a calculation. This is particularly interesting to distribute a computation in a NDT problem as it involves a lot of probe scanning positions that can be solved independently. For instance, the code Code\_Carmel3D can be launched on the cluster «Ivanoé», the supercalculator of EDF, in service since October 2010, and proposing a theoretical maximal computation power of 200 teraflops (200 000 billions of operations/second), which is equivalent to 30 000 conventional computers. This allows Code\_Carmel3D to solve large size configurations such as FEM mesh of 5 to 7 million elements. Flux software can also realize distributed computation. Finally, the architecture GPGPU, Graphic cards processor, is also a potential solution to solve parallel computation, well suited for integral formulations models [8].

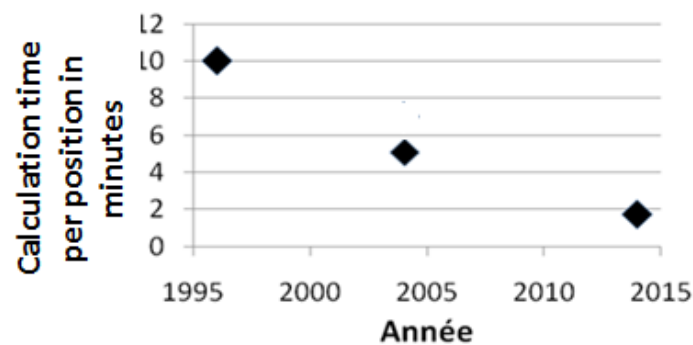

**FIGURE 1 : Evolution of computation time for the benchmark TEAM workshop 8 by Finite Element Methods (very coarse mesh in 1996, 16 times bigger mesh in 2004 and 2014)**

### 3.2 Evolution of semi-analytical codes

Regarding semi-analytical codes, there were mostly limited to canonical configurations in the year 2000s. For instance, in 2005, CIVA ET could only simulate planar geometries. Tubular configurations inspections with rotating probe or bobbin coils have been added in 2007 [16]. Since then, the features have been again extended [17] in order to compute accurately the cases with very thin flaw, the possibility to simulate several flaws in the same model, or to combine flaws together allowing describing more realistic crack profiles. Probe modelling has been also enhanced dramatically with the use of modal methods or hybrid approaches (modal-numerical model) giving the possibilities to simulate advanced sensors such as Eddy Current arrays, shielded probe or sensor with ferromagnetic cores very quickly.

Mesh size is a less relevant parameter as the purpose of semi-analytical methods is precisely to limit the discretization volume to reach very competitive calculation times. For instance, nowadays, the benchmark TEAM WORKSHOP 15 is solved in CIVA in about 20 seconds with a conventional computer.

## 4. Examples of definition and results obtained on these benchmarks

### 4.1 Benchmark #2: Separated Functions Sensor

As said above, this case aims at illustrating the problems of through-wall flaw in thin nonmagnetic parts such as steam generator tubes. A first part of this benchmark implies a single coil working in absolute mode. The corresponding results had already been reported in various papers [18], [19], [20]. Here, the second part of this benchmark is presented, involving an eddy current sensor with 2 coils operating in separated functions and absolute measurement, also called “Reflection mode“.

The comparison is done on the flaw called « F5 », a small Through Wall notch (length 2 mm, aperture 0.1 mm), after a calibration on the flaw F7 (length 10 mm, aperture 0.3 mm, depth 40% wall thickness, surface breaking), with a signal put at (1V, 0°).

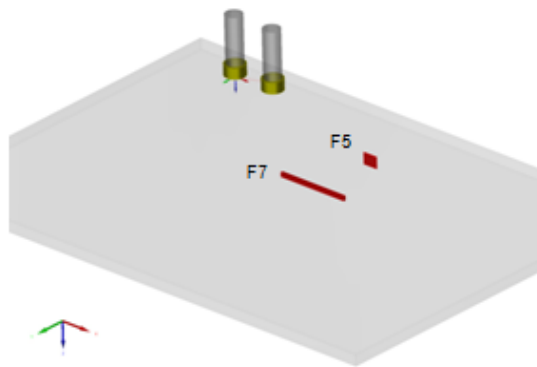

Both flaws are shown on

FIGURE 4. Experimental acquisitions have been performed by CEA.

Input parameters relative to the part and the sensor are reported in table 1 & 2. A 2D view of the sensor is shown in FIGURE 3.

Test piece	Planar slab
Thickness	1,55 mm
Material	Inconel 600
Electrical conductivity	0,992 MS/m
Relative permeability	1

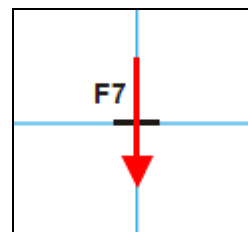

FIGURE 2 : Sensor scanning vs notch

Reference Flaw F7		Target Flaw F5	
Length	10 mm	Length	2 mm
Aperture	0,3 mm	Aperture	0.1 mm
Depth	40%	Depth	100%
Calibration voltage	1V		X
Calibration Phase	0°		X

Table 1 : B2 – Test piece and flaws parameters

	Emitting Coil	Receiving coil
Ferromagnetic core	ferrite (B30)	ferrite (B30)
Ferrite core dimensions	2.3 x 8 mm	2.3 x 8 mm
Lift-Off	0,3 mm	

Ferrite relative permeability	1100	1100
Coil Internal Diameter	2.3 mm	2.3 mm
Coil External Diameter	2.8 mm	2.8 mm
Coil width	1.5 mm	1.5 mm
Number of turns	90	90
Emitter-Receiver Inter-axis distance	6 mm	

*Table 2 : B2 - Separated functions sensor parameter*

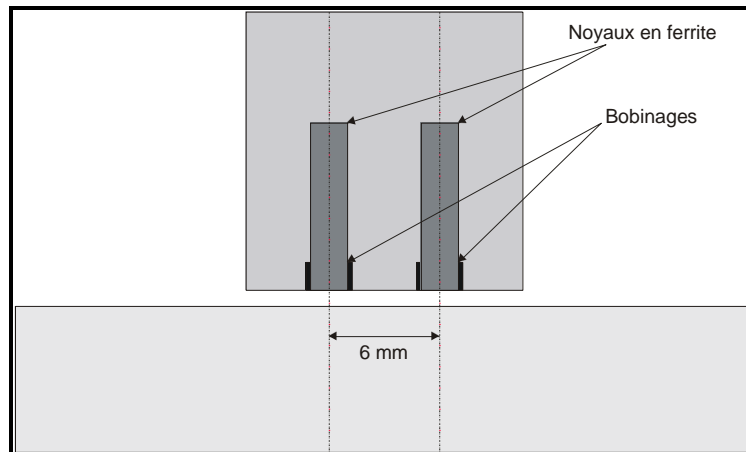

*FIGURE 3 : B2 – Separated functions sensor*

This benchmark #2 has been solved with 3 different codes:

- The semi-analytical software: CIVA – ET version 11.0,
- The FEM software: Flux, version 11.1.2
- The FEM code Code\_Carmel3D, version 2.4.0, referenced C3D in table 3 and 4.

Two new features of CIVA v11.0 has been used in this benchmark, compared to the first results given in previous papers on this benchmark [18]:

- Automatic mesh of the flaw,
- A specific surface model (Boundary Element Method) more efficient and more precise for thin flaw than volume model.

Simulation results have been compared to experimental results.

FIGURE 6 and FIGURE 7 give the calibrated signals for the flaw F5, at 100 kHz & 300 kHz. Table 3 and 4 summarize the phase and amplitude obtained experimentally and with the 3 simulation tools.

100kHz	Amplitude (V)	Amplitude difference	Phase (°)	Phase difference
Experiment	1,01	Reference	-16,7°	Reference
CIVA 11.0	0,97	4%	-17,3°	0,6
Flux 11.1.2	0,93	8%	-16°	-0,7°
C3D 2.4.0	0,95	6%	-16,9	0,3°

*Table 3: B2 – Separated functions - Amplitudes & phases at 100 kHz*

300kHz	Amplitude (V)	Amplitude difference	Phase (°)	Phase difference
Experiment	0,75	Reference	-34,6°	Reference



<b>CIVA 11.0</b>	0,74	1%	-33,4°	-1,2°
<b>Flux 11.1.2</b>	0,70	7%	-32,7°	-1,9°
<b>C3D 2.4.0</b>	0,70	7%	-34,4°	0,2°

Table 4: B2 – Separated functions - Amplitudes & phases at 300 kHz

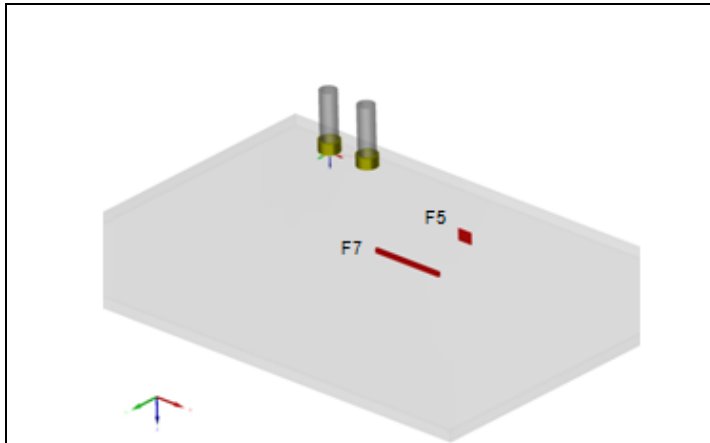

FIGURE 4 – Simulated configuration in CIVA 11.0

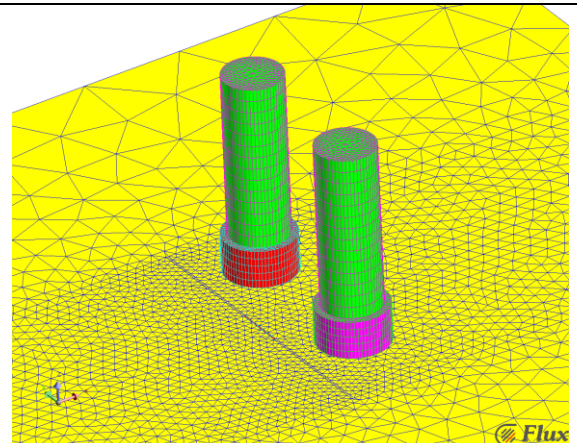

FIGURE 5 – Configuration mesh in Flux 11.1

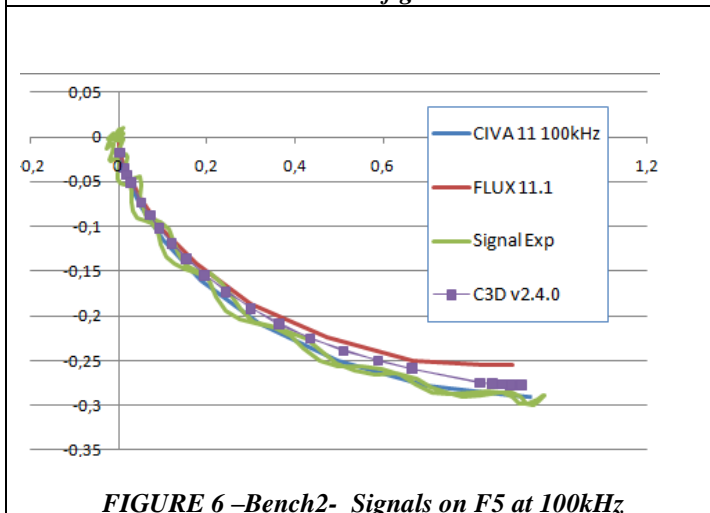

FIGURE 6 –Bench2- Signals on F5 at 100kHz

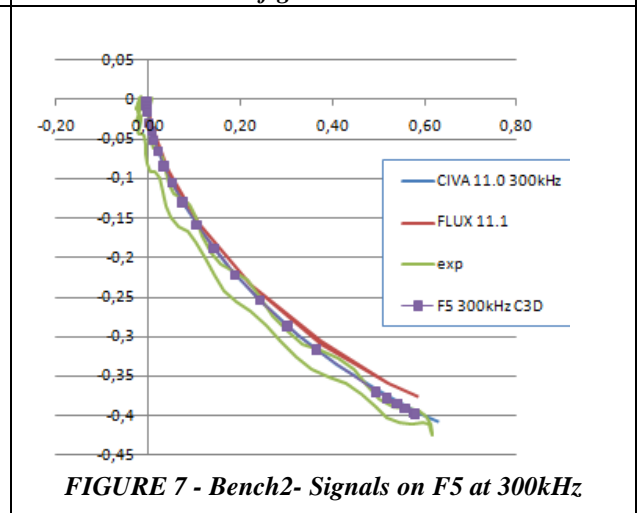

FIGURE 7 - Bench2- Signals on F5 at 300kHz

#### 4.2 Benchmark #6

The benchmark #6 deals with online Eddy Current inspection of steel tubes without weld at manufacturing stage. Therefore, this case addresses the needs of steel industry. Inspection technique is based on encircling coils. Flaws are Flat Bottom Holes, Through Wall Hole or grooves, as represented in FIGURE 8. This test-case involves 2 configurations for the tube:

- “Centered case”: The tube is correctly centered in the inspection set. It corresponds to optimal inspection configuration.
- “Off-centered case”: With a shift of 2mm between the tube axis and the inspection coils axis. This corresponds to a situation where the vibrations of the tube in the inspection bench can produce such off-centering. More generally, it addresses a major issue, which is the reproducibility of inspections in production.

<b>Tube dimensions</b>	External Diameter : 32 mm - Thickness : 8 mm
<b>Tube material :</b>	Stainless Steel TP304L / Conductivity : = 1,43 MS/m Relative Permeability: 1
<b>FBH 8 :</b>	Through Wall Hole (depth : 8 mm) Diameter : 3,5 mm

<b>FBH 2 :</b>	Flat Bottom Hole, depth 2 mm. Diameter : 3,5 mm
<b>FBH 3 :</b>	Flat Bottom Hole, depth 3 mm. Diameter : 3,5 mm
<b>FBH 5:</b>	Flat Bottom Hole, depth 5 mm. Diameter : 3,5 mm
<b>Circular groove :</b>	External circular groove ; Depth : 0,5 mm, Width: 1 mm

*Table 5 : B6 – Description of the configuration*

The tube has an external diameter of 32mm and a thickness of 8mm. It is made of austenitic stainless steel TP304L, containing mainly iron (~73%), chromium (~18%) and nickel (~9%). Electromagnetic material properties, which are necessary to know for simulation, are given in table 5, as well as the dimensions of the tube and flaws. Sensor parameters are listed in table 6. The calibration is done on the Flat Bottom Hole of 3 mm depth.

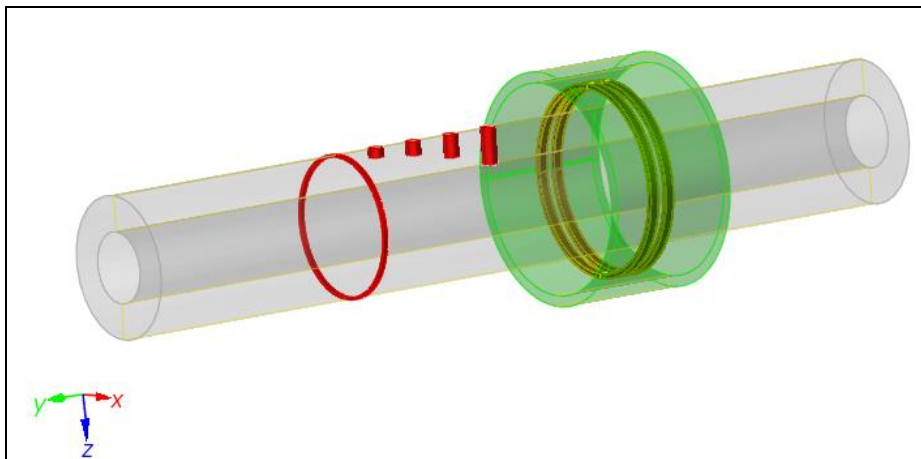

*FIGURE 8 : B6 – Representation of the configuration in CIVA*

<b>Emitting Coil</b>	<b>Receiving Coils</b>
Internal Diameter : 47 mm Thickness : 2,4 mm Width : 30 mm Nbr Turns : 200	Internal Diameter : 41 mm Thickness : 1 mm Width : 2 mm Nbr Turns: 200 Air gap between coils: 2mm (Configuration « 2-2-2 »)

*Table 6 : B6 – Coils parameters*

<b>Centered FBH2</b>	<b>Amplitude (V)</b>	<b>Amplitude Difference</b>	<b>Phase (°)</b>	<b>Phase difference (°)</b>
<b>Experiment</b>	0,92	<i>Reference</i>	97,9	<i>Reference</i>
<b>CIVA 11.0</b>	0,89	-3%	96,5	-1,4
<b>Flux 11.1</b>	0,90	-2%	96,4	-1,5°
<b>Centered FBH5</b>	<b>Amplitude (V)</b>	<b>Amplitude Difference</b>	<b>Phase (°)</b>	<b>Phase difference</b>
<b>Experiment</b>	0,99	<i>Reference</i>	83,5	<i>Reference</i>
<b>CIVA 11.0</b>	1,01	2%	85,3	1,8
<b>Flux 11.1</b>	1,00	2%	86,0	2,5
<b>Centered FBH8</b>	<b>Amplitude (V)</b>	<b>Amplitude Difference</b>	<b>Phase (°)</b>	<b>Phase difference</b>
<b>Experiment</b>	0,98	<i>Reference</i>	84,5	<i>Reference</i>
<b>CIVA 11.0</b>	0,99	0%	84,7	-0,2
<b>Flux 11.1</b>	0,98	0%	86,6	-2,1

*Table 7 : B6 – Comparison between experimental results (reference) and simulations for the « centered case » at 50kHz*

		<b>Amplitude (V)</b>	Amplitude difference	<b>Phase (°)</b>	Phase difference (°)
Off-centered FBH2	CIVA 11.0	1,70	2,7%	102,3	-0,4°
	Flux 11.1	1,75		101,9	
Off-centered FBH5	CIVA 11.0	1,92	1,4%	91,5	1,1°
	Flux 11.1	1,95		92,6	
Off-centered FBH8	CIVA 11.0	1,88	1,8%	90,2	3°
	Flux 11.1	1,91		93,2	

*Table 8 : B6 – Comparison between simulated results for the « off-centered case » at 50kHz*

Table 7 gives the results of the « centered case » for experiments and 2 different simulation tools at 50 kHz, which show a good agreement. Table 8 compares simulation results for the off-centered case, with also a good agreement between the models. This is an example of a parametric study (influence of the off-centering) where this is not easy to obtain reliable measurement data and this is interesting to perform comparison directly between simulation codes. The other frequencies, 3 kHz and 100 kHz, have also been done and also show a good agreement.

#### 4.3 Description of benchmark #9

This benchmark and the results obtained by CIVA 11 have been presented at the conference QNDE 2013 [25]. It has been originally set up by the CEA and Western Macedonia University, which performed the experimental acquisitions. This configuration addresses aeronautics issues with a work piece made of two conductive plates fastened together with a rivet. The proposed configuration is a simplified version of the industrial case: quite large bore and simple coil operating in absolute mode at two frequencies: 1 & 5 kHz. Measurements have been performed at the impedance meter, therefore no calibration is required.

An exhaustive description of the configuration is given in table 9. FIGURE 9 shows the simulation configuration defined in the CIVA software. On FIGURE 10, FIGURE 11, FIGURE 12 and FIGURE 13, are respectively given the impedance plane results of configurations 1 to 4 at 1 kHz obtained with CIVA where a good agreement can be observed (at 5 kHz, a good agreement has been also reached; read [25] for the detailed results).

<b>Test Piece : 1 or 2 plates</b>	
Thickness	2 mm
Electrical conductivity	17,4 MS/m
Relative Magnetic Permeability	1
Inter-plate Gap	70 μm

<b>Sensor</b>	
Internal radius	7mm
External radius	12mm
Height	4mm
Nbr of turns	1650
Lift-off	1,082 mm

<b>Flaws</b>			
Hole	Hole radius	10	mm
	Depth	100%	
Notch	Length	9,8	mm
	Aperture	0,236	mm
	Depth	100%	

<b>Inspection</b>	
Absolute Mode sensor	
Frequencies	1 & 5 kHz

Table 9 : B9 - Descriptions of configurations parameters

Situation #	Nbr of plates	Plate with the hole (*)	Plate with the notch (*)	(*) (0 = No Flaw, 1 = Upper plate, 2 = Lower plate)
1	1	1	1	
2	2	1 & 2	2	
3	2	1 & 2	1	
4	1	1	0	

Table 10 : B9 - Definition of each configuration by combining mock-ups and notch

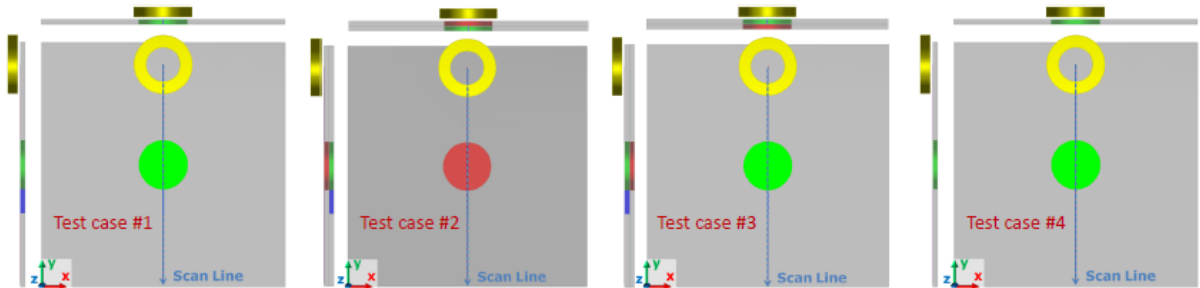

FIGURE 9 : B9 - Representation of the 4 configurations

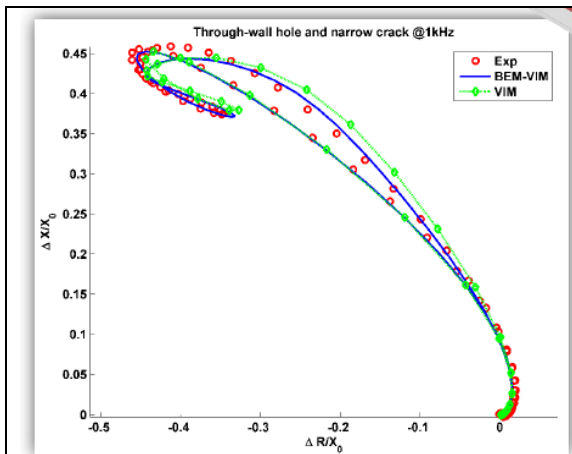

FIGURE 10 : B9 – Impedance plane of configuration 1 at 1kHz

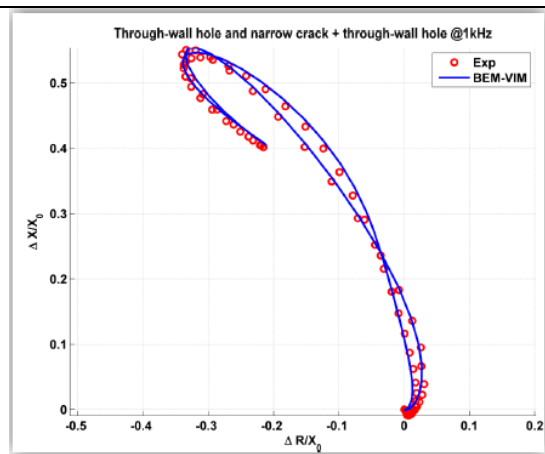

FIGURE 11 : B9 – Impedance plane of configuration 2 at 1kHz

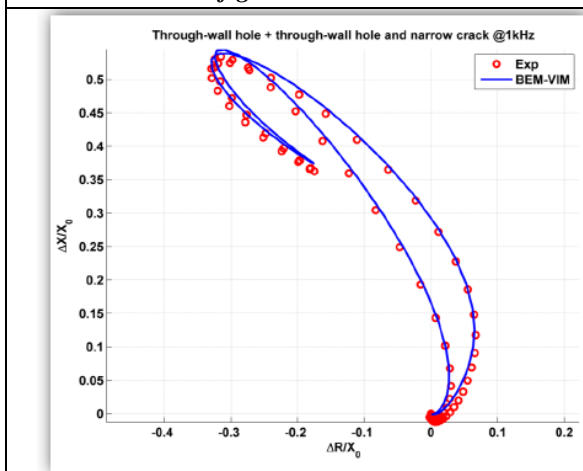

FIGURE 12 : B9 – Impedance plane of configuration 3 at 1kHz

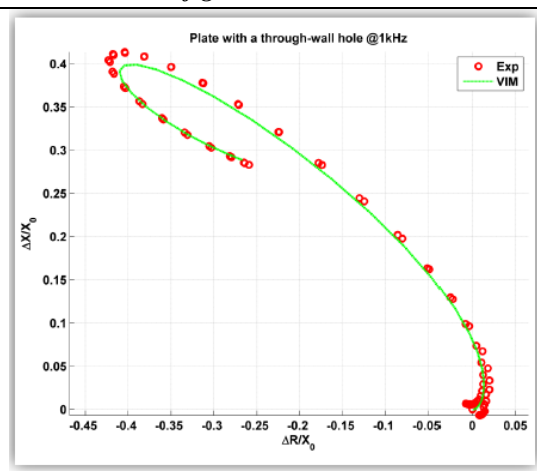

FIGURE 13 : B9 – Impedance plane of configuration 4 at 1kHz

## 5. Conclusion

Numerical simulation can be very helpful to solve industrial issues at different stages of a NDT process. However, to use them with confidence, one or several validation steps are necessary.

The working group from the French Society of NDT « COFREND » aims at proposing realistic benchmarks for Eddy Current Testing, close to industrial needs, allowing to validate the code by comparison with experimental data and/or simulation codes.

This article also highlights the evolution of computation performance for the last 20 years, showing a real improvement of calculation times while an increase in the modeling capabilities (type of cases to be solved, size of mesh “allowed” with FEM models, etc.). This will allow modeling software to address more and more complex situations in a limited amount of time allowing extensive parametric studies to be performed. It should help to improve again the development and optimization of inspection method while improving their reliability.

The exhaustive list of test cases proposed by the group is given in this paper. While some of them are still in the description stage, the results of 3 benchmarks are given in this paper showing an overall good agreement.

While helping to validate the accuracy of simulation results by comparison with experimental data, another benefit of the working group activity is to underline the necessity to describe exhaustively a simulation configuration, and in particular, the importance of mastering all influential input parameters.

In the coming years, the working group will continue to propose benchmarks, will inform the community about the results obtained and the improvement of simulation performance, in order to help the acceptance of simulation software in the NDT industry.

## References

[1] Bilicz, S.; Vazquez, E.; Gyimothy, S.; Pavo, J.; Lambert, M., "Kriging for Eddy-Current Testing Problems," *Magnetics, IEEE Transactions on*, vol.46, no.8, pp.3165, 3168, Aug. 2010, doi: 10.1109/TMAG.2010.2043418

[1b] Dominguez, N., Reboud, C., Dubois, A. and Jenson, F., Dominguez, N., A New Approach of Confidence in POD Determination Using Simulation, *AIP Conf. Proc.* **1511**, 1749 (2013); <http://dx.doi.org/10.1063/1.4789252>.

[2] [http://www.agence-nationale-recherche.fr/projet-anr/?tx\\_lwmsuivibilan\\_pi2\[CODE\]=ANR-13-MONU-0011](http://www.agence-nationale-recherche.fr/projet-anr/?tx_lwmsuivibilan_pi2[CODE]=ANR-13-MONU-0011)

[3] Reverdy, F., Dominguez, N., NDT Modeling tools applied to the aeronautic industry: examples in CIVIA, 5th International Symposium on NDT in Aerospace, 13-15th November 2013, Singapore

[4] Bisiaux, B., Maurice, L, Paillard, S., Comparison Of Two Eddy Current Simulation Methods In Steel Pipes, ICNDE 2013 Ljubljana Slovénie

[5] Hubert C., Deydier, S., de Roumilly L., Lhuillier, P.-E., Chassignole, B., "Use Of Advanced Simulation Tools: Some Examples In The French Qualification Process For Ultrasonic Applications", ICNDE 2013.

[6] “EPRI Launches NDE Modeling and Simulation Center to Enhance Nondestructive Evaluation », <http://mydocs.epri.com/docs/CorporateDocuments/Newsletters/NUC/2011-07/07a.html>

- [7] Li, Y., Berthiau, G., Feliachi, M., Cheriet, A., 3D Finite Volume Modeling of ENDE Using Electromagnetic T-Formulation, Hindawi Publishing Corporation, Journal of Sensors, Volume 2012, Article ID 785271,
- [8] Rubeck, C., Bannwath, B., Chabedec, O., Guichon, J-M., Delinchant, B., Yonnet, JP, Compression par ondelettes de formulations intégrales sur architecture GPGPU, Numelec 2012.
- [9] ENIQ, ENIQ Recommended Practice 6: the Use of Modeling in Inspection Qualification, ENIQ report No. 45, vol. 6, 2nd issue, 2011.
- [10] Turner, LR., The TEAM Workshops : What's Old? What's New? Asian TEAM Workshop, Yichang City, China, October 13-14, 1996
- [11] Takagi, T., Uesaka, M., Miya, K., Electromagnetic NDE research activities in JSAEM, ENDE 1996, Tokyo, IOS Press, pp. 9-16.
- [12] Moreau, O., Gilles-Pascaud, C., Reboud, C., Démarche de validation de code de simulation en END par courants de Foucault, Journées COFREND 2008 (TOULOUSE)
- [13] Zorni, C., Reboud, C., Decitre, J.M., Santandréa, L., Le Bihan, Y., Ventre, L., Tamburrino, A., and Lambert, M., "Modelling eddy current testing of ferromagnetic medium", International Journal of Applied Electromagnetics and Mechanics, vol.39, no.1, pp.245-250, Jan. 2012 doi : 10.3233/JAE-2012-1467.
- [14] Maurice, L., Costan, V., Guillot, E., Thomas, P, Using simulation tools for performance demonstrations of eddy current NDE Wears on Steam Generator Tubes, QNDE 2012
- [15] Mayos, M., Levy, R., Sollier, T., Tretout, H., Betsch, N., Foucher, F., Lepaul, S., Neau, G., Nicolas, A., Premel, P., Groupes de Travail COFREND en END par courants de Foucault : bilan et perspectives, Journées COFREND, Beaune, Mai 2005.
- [16] Le Ber, L., Calmon, P., Sollier, T., Mahaut, S., Benoist, P., Advances of simulation and expertise capabilities in CIVA platform, LQNDE Vol. 25, 2006, pp. 684-691
- [17] Miorelli, R.; Reboud, C.; Lesselier, D.; Theodoulidis, T., "Eddy Current Modeling of Narrow Cracks in Planar-Layered Metal Structures," Magnetics, IEEE Transactions on Magnetics, vol.48, no.10, pp.2551-2559, Oct. 2012 doi: 10.1109/TMAG.2012.2197403
- [18] Mayos, M., Moreau, O., Costan, V., Gilles-Pascaud, C., Reboud, C., Buvat, F, "A Benchmark-based Approach For The Validation Of Eddy Current Simulation Codes In Support Of Nuclear Power Plants Inspection, ENDE 2009.
- [19] Mayos, M., Moreau, O., Costan, V., Gilles-Pascaud, C., Reboud, C., Buvat, F., Developing and using benchmarks for eddy current simulation codes validation to address industrial issues, QNDE 2010.
- [20] Mayos M., Sollier T., Lambert M., Gilles-Pascaud C., Moreau O., Dessendre M., Deneuille F., Reboud C., Foucher F., Mistral Q., Debrouse M., Levy R., Multi-domain industrial benchmarks for eddy current modeling: the COFREND working group, Proceedings of ECNDT2010, Moscow, 2010.
- [21] Deneuille, F., Desdoit, E., Bisiaux, B., Mayos, M., Comparaison De Deux Méthodes De Simulation Des Contrôles Par Courants De Foucault Sur Tubes En Acier, COFREND 2011.

[22] Deneuville, F., Reboud, C., Foucher, F., Lesselier, D., Maurice, L., Comparison of Two Modeling Approaches of Eddy Current Industrial Non-Destructive Testing of Steel Pipes, QNDE 2013.

[23] Skarlatos, A.; Pichenot, G.; Lesselier, D.; Lambert, M.; Duchene, B., "Electromagnetic Modeling of a Damaged Ferromagnetic Metal Tube by a Volume Integral Equation Formulation," Magnetics, IEEE Transactions on , vol.44, no.5, pp.623,632, May 2008  
doi: 10.1109/TMAG.2008.918206

[24] Miorelli, R., Reboud, C., Theodoulidis, T., Solution to the WFNDEC 2013 Eddy Current Benchmark Problem Via a Coupled VIM - BEM Approach, Department of Mechanical Engineering, Kozani, Greece. <http://www.wfndec.org>

[25] Mayos, M., Lambert, M., Gilles-Pascaud, C., Dessendre, M., Dominguez, N., Foucher, F., Abakar, A., Groupe De Travail Cofrend Sur La Simulation Des End Par Courants De Foucault - Bilan D'activites, COFREND 2008.